

Article number: 604144048050

Description: Timing belt pulley with hub
HTD 48 8M 50

Measures

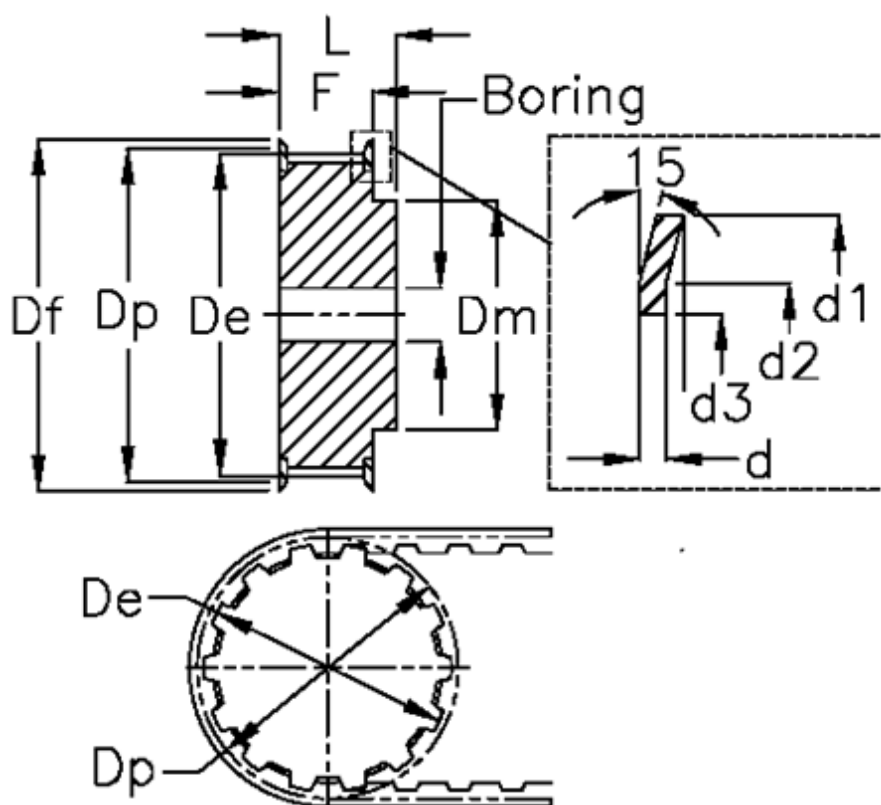

Bore = 18	Dp	= 122.23
d = 1.5	F	= 60
d1 = 128	Flange type	= F40
d2 = 124	L	= 70
d3 = 107	Tooth number	= 48
De = 120.86	Type	= 8M
Df = 128	Weight	= 4.3
Dm = 80	Width	= 50